

Chiusure
residenziali

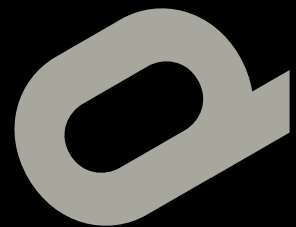

apostolidaniele

Chiusure residenziali/

Le chiusure residenziali coniugano estetica e funzionalità sfruttando il minimo ingombro. Le prestazioni sono implementate da un'alta coibentazione termica ed un alto grado di sicurezza.

Design personalizzato/ Estetica unica nata dalla vostra creatività, carattere distintivo per coloro che amano qualità e ricercatezza.



Large **90** /
Medium **92** /
Small **94** /
Box **96** /
Lateral **98** /
Air **100** /
Window **102** /
Porte pedonali **104** /

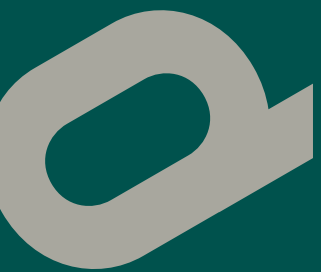

meccanica/

RSE/

La migliore soluzione per porte sezionali con misure massime fino a larghezza 3500 mm e altezza 2055 mm, dotate di molle a trazione che realizzano il sollevamento.

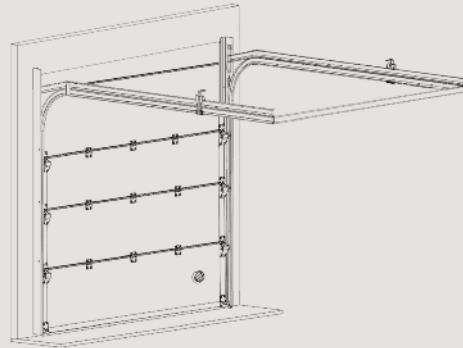

La versione di serie della meccanica residenziale è fornita con binario doppio e molle a trazione poste in verticale (la sicurezza è garantita da un doppio cavo di movimentazione e un sistema a molle concentrico). L'architrave richiesto è di 150 mm e le spallette da 100 mm.

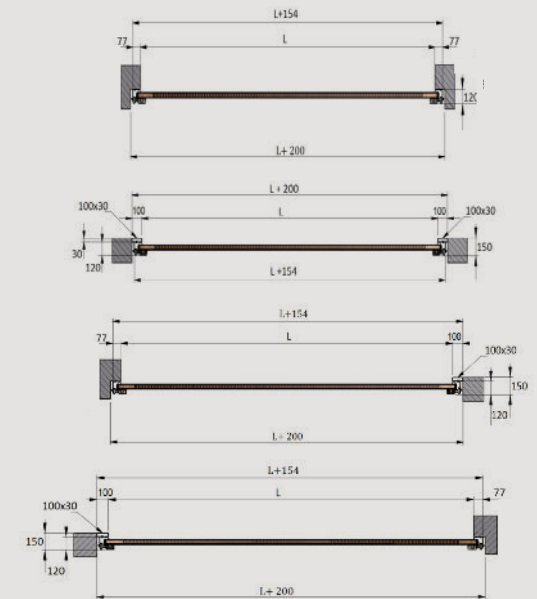

RSC/

La migliore soluzione per porte sezionali di tutte le misure o dotate di accessori quali la porta pedonale integrata o i rinforzi strutturali per porte fino a grandi dimensioni.

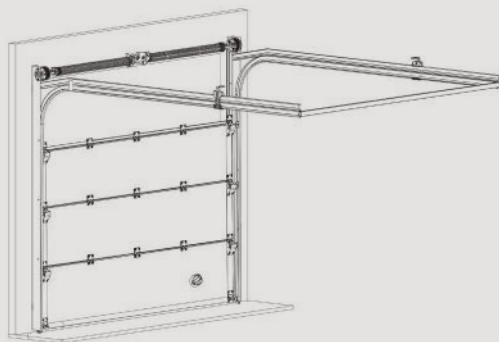

La versione di serie della meccanica residenziale è fornita con doppio binario superiore e molle frontali a torsione. L'architrave richiesto è di soli 150 mm e le spallette da 100 mm. A richiesta possono essere fornite soluzioni con molle posteriori o scorrimenti per soffitto inclinato o ad architrave rialzato di 250 mm.

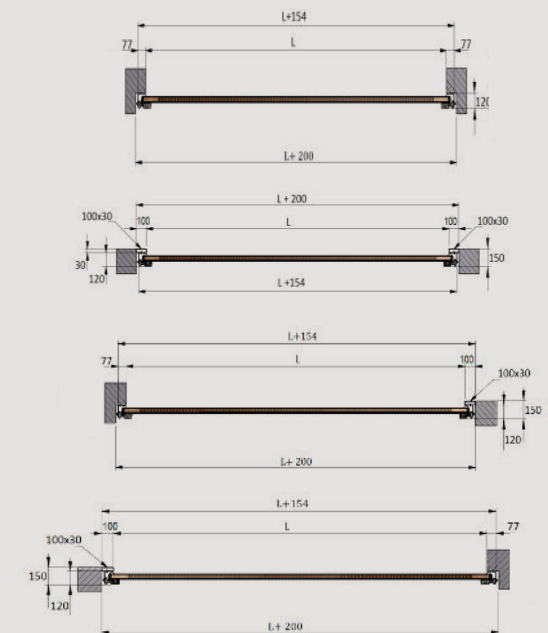

Large

Le porte sezionali per garage Large sono caratterizzate da un'estetica essenziale che ben si adatta ai contesti più moderni.

specifiche/

Installazione
interno/esterno

Montante a L
in lamiera zincata
pressopiegata

Manto
pannello in lamiera zincata
pressopiegata, riempito
con poliuretano espanso
e verniciato RAL o simil
legno

Pannello
senza doghe

Superficie
goffrata legno,
effetto legno o liscio

Varianti RAL
a richiesta

sistemi di apertura/

manuale
motorizzato

selettore di apertura
telecomando
sblocco motore
lampeggiante
fotocellula

optional/

meccanica/

finiture/

goffrato legno/

effetto legno/

liscio/

RSC

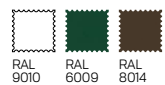

RSE

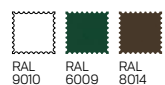





















Medium

Le porte sezionali per garage Medium presentano un'estetica sobria conferita dalla modularità delle doghe.













specifiche/	sistemi di apertura/	optional/
Installazione interno/esterno	manuale motorizzato	selettore di apertura telecomando sblocco motore lampeggiante fotocellula
Montante a L in lamiera zincata pressopiegata		
Manto pannello in lamiera zincata pressopiegata, riempito con poliuretano espanso e verniciato RAL o simil legno		
Pannello con doga 25cm		
Superficie goffrata legno, effetto legno o liscio		
Varianti RAL a richiesta		

meccanica/	finiture/		
	goffrato legno/	effetto legno/	liscio/
RSC	 RAL 9010  RAL 6005  RAL 8014	 Rovere sbiancato  Quercia chiaro  Quercia scuro	 RAL 9010  RAL 7016  RAL 9006
RSE	 RAL 9010  RAL 6005  RAL 8014	 Rovere sbiancato  Quercia chiaro  Quercia scuro	 RAL 9010  RAL 7016  RAL 9006

Small

Le porte sezionali per garage Small si propongono con un'estetica contemporanea grazie al pannello con doghe da 10 cm.

specifiche/	sistemi di apertura/	optional/
Installazione interno/esterno	manuale motorizzato	selettore di apertura telecomando sblocco motore lampeggiante fotocellula
Montante a L in lamiera zincata pressopiegata		
Manto pannello in lamiera zincata pressopiegata, riempito con poliuretano espanso e verniciato RAL o simil legno		
Pannello doghe 10cm		
Superficie gofrata legno, effetto legno o liscio		
Varianti RAL a richiesta		

meccanica/	finiture/		
	goffrato legno/	effetto legno/	liscio/
RSE	 RAL 9010  RAL 9006  RAL 9002	 Quercia chiaro  Quercia scuro	 RAL 9006
RSC	 RAL 9010  RAL 9006  RAL 9002	 Quercia chiaro  Quercia scuro	 RAL 9006







Box

La porta sezionale per garage Box conferisce un'immagine raffinata e classica.

specifiche/	sistemi di apertura/	optional/
Installazione interno/esterno	manuale motorizzato	selettore di apertura telecomando sblocco motore lampeggiante fotocellula
Montante a L in lamiera zincata pressopiegata		
Manto pannello in lamiera zincata pressopiegata, riempito con poliuretano espanso e verniciato RAL o simil legno		
Pannello con riquadro 		
Superficie gofrata legno		
Varianti RAL a richiesta		

meccanica/	finiture/
	gofrato legno/
RSC	 RAL 9010
RSE	 RAL 9010

Lateral

Lo scorrimento laterale è ideale per contesti con architrave assente o ridotta (H60mm), o per situazioni che richiedano di contenere l'ingombro del passaggio in larghezza (S40mm / S100mm).

specifiche/

Pannello verticale disponibile in versione

Large
Medium
Small

Superficie



























goffrata legno,
effetto legno o liscia

Varianti RAL

a richiesta

pannello/

finiture/







	goffrata legno/	effetto legno/	liscio/
Large	 RAL 9010  RAL 6009  RAL 8014	 Quercia chiaro  Quercia scuro	 RAL 1015  RAL 9010  RAL 9006  RAL 7016  RAL 9016  Corten
Medium	 RAL 9010  RAL 6005  RAL 8014	 Rovere sbiancato  Quercia chiaro  Quercia scuro	 RAL 9010  RAL 7016  RAL 9006
Small	 RAL 9010  RAL 9006  RAL 9002	 Quercia chiaro  Quercia scuro	 RAL 9006





Air

La porta sezionale Air mantiene una perfetta ventilazione del vano, oltre ad un effetto estetico fortemente caratterizzante.



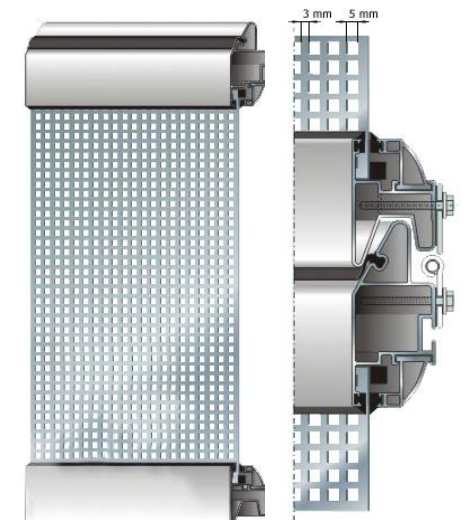



specifiche/	sistemi di apertura/	optional/						
<p>Installazione interno/esterno</p>	<p>manuale motorizzato</p>	<p>selettore di apertura telecomando sblocco motore lampeggiante fotocellula</p>						
<p>Montante a L in lamiera zincata pressopiegata</p>								
<p>Manto composto da telaio in alluminio con riempimento in lamiera microforata zincata</p>								
<p>Telaio in alluminio rinforzato con pannelli in acciaio perforato</p>								
<p>Utilizzo ideale per autorimesse ed esercizi condominiali</p>								
<p>Possibilità di: - porta pedonale inserita o laterale esterna - motorizzazione ad utilizzo intensivo - semaforo per la gestione delle uscite - sistemi di sicurezza evoluti</p>								
<p>finiture/</p> <table border="0"> <tr> <td>telaio</td> <td>riempimento</td> </tr> <tr> <td></td> <td></td> </tr> <tr> <td>alluminio anodizzato</td> <td>RAL 9006</td> </tr> </table>	telaio	riempimento			alluminio anodizzato	RAL 9006		
telaio	riempimento							
								
alluminio anodizzato	RAL 9006							





Window

La porta sezionale Window si contraddistingue per il design pulito e moderno conferito dalle ampie lastre vetrate.

specifiche/	sistemi di apertura/	optional/						
<p>Installazione interno/esterno</p>	<p>manuale motorizzato</p>	<p>selettore di apertura telecomando sblocco motore lampeggiante fotocellula</p>						
<p>Montante a L in lamiera zincata pressopiegata</p>								
<p>Manto composto da telaio in alluminio satinato o verniciato RAL con finestrature</p>								
<p>Telaio in alluminio rinforzato con pannelli in acciaio</p>								
<p>Possibilità di: -porta pedonale inserita o laterale esterna -motorizzazione ad utilizzo intensivo -semaforo per la gestione delle uscite -sistemi di sicurezza evoluti</p>								
<p>finiture/</p> <table border="0"> <tr> <td>telaio</td> <td>riempimento</td> </tr> <tr> <td></td> <td></td> </tr> <tr> <td>alluminio anodizzato</td> <td>RAL 9006</td> </tr> </table>			telaio	riempimento			alluminio anodizzato	RAL 9006
telaio	riempimento							
								
alluminio anodizzato	RAL 9006							

Porte pedonali/

Pedonale integrata/

Porta pedonale integrata ricavata all'interno della porta sezionale. Ideale per contesti nei quali è presente la necessità di passaggi pedonali.

/Disponibile nelle misure L800mm e L1200mm completa di chiudiporta, maniglia o maniglione antipanico e serratura standard o a 3 punti di chiusura. Possibilità di soglia ribassata calpestabile per agevolare il passaggio di mezzi su ruote.



Soglia tradizionale

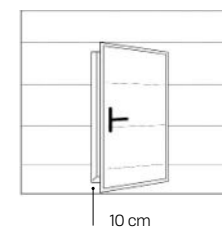

Soglia ribassata

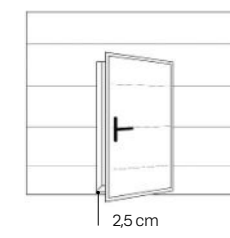

Con cornice Senza cornice



Pedonale laterale/

Porta pedonale laterale realizzata su misura con gli stessi pannelli della porta sezionale, completa di chiudiporta, struttura portante in profili di alluminio e guarnizioni di tenuta su tutto il perimetro.

/La porta con doppia anta è disponibile a richiesta, mentre il telaio può essere ordinato con o senza cornice.



Segui
apostoli.it

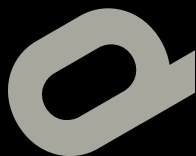

apostolidaniele

Sede legale/

Viale Duca degli Abruzzi 167
25124 Brescia, Italy

Sede amministrativa e produttiva/

Via Palazzo SNC
25010 Montirone (BS), Italy

Tel. / Fax

+39 **030 2170484**
+39 **030 2170482**

apostoli.it
clienti@apostoli.it